

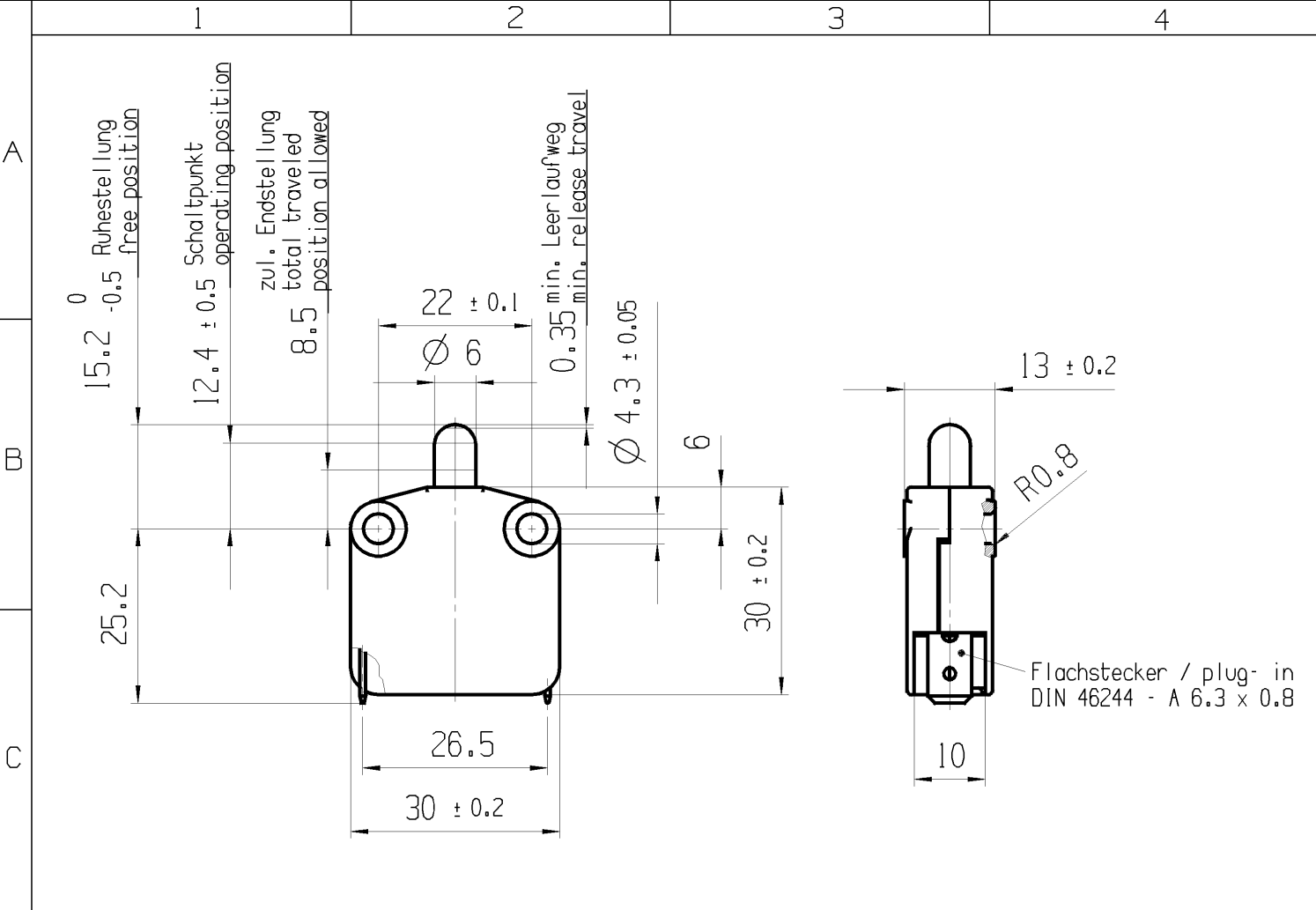

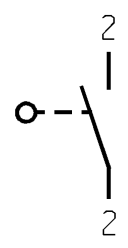

VERTRAULICH CONFIDENTIAL
 © THIS DRAWING IS THE EXCLUSIVE PROPERTY OF MARQUARDT GMBH. WITHOUT THEIR CONSENT IT MAY NOT BE REPRODUCED OR GIVEN TO THIRD PARTIES.
 © Alle Rechte bei Marquardt GmbH, auch fuer den Fall von Schutzrechtsmeldungen. Jede Veruegungsbefugnis, wie Kopier- und Weitergaberecht, bei uns.



Flachstecker / plug-in
DIN 46244 - A 6.3 x 0.8



Aufschrift
 Marking
 MARQUARDT 
 1117.
 16(1)/400 ~ T85
 05
 12A 125 - 250 V AC
 1/6 HP 125 V AC
 1/2 HP 250 V AC
 R84  
 T.-Nr. 06057400

Schliesser 1-polig
 Schalt-Betaetigungskraft 3.5N ± 0.5N
 Differenzweg (Weg zwischen Schaltpunkt und Rueckschaltpunkt) max. 2.6

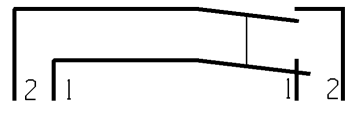

SPNO
 actuating force 3.5N ± 0.5N
 movement differential (movement between operating position and release position) max. 2.6

G-Konform nach IEC 60335-1:2001 Kap.30
 G-matching IEC 60335-1:2001 clause 30



Auf Verpackung/on box: T.-Nr. 06057400
G

Rd < 100 mΩ bei/at I > 1A

fuer Form und Lage FOR SHAPE AND LOC. fuer Winkel FOR ANGLE		Allgemeintoleranzen UNTOLERANCED DIMENSIONS				Pause COPY	Blatt SHEET 01	TYP K	Zeichn./DRAWING NO. 11170106	Index c
		PROJEKTION 	Abmasse und Nennmassbereiche Angaben in mm	Laenge LENGTH	Radien RADII					

c	48695	10.08.06	HHE			
b	47541	15.05.06	BRC			
a	44287	04.08.05	BRC			
	35735	19.05.04	WJ			
Ausg. ISSUE	Aenderung REVISION	gez. DRAWN BY	Ausg. ISSUE	Aenderung REVISION	gez. DRAWN BY	



CAD: NX V2.0
 gez./DRAWN BY 04.08.05 BRC
 gepr./CHECKED BY
 Ersatz fuer/REPLACEMENT OF
 Zg.gl.Nr.v.19.05.04

GERAETESCHALTER
 appliance switch

MARQUARDT

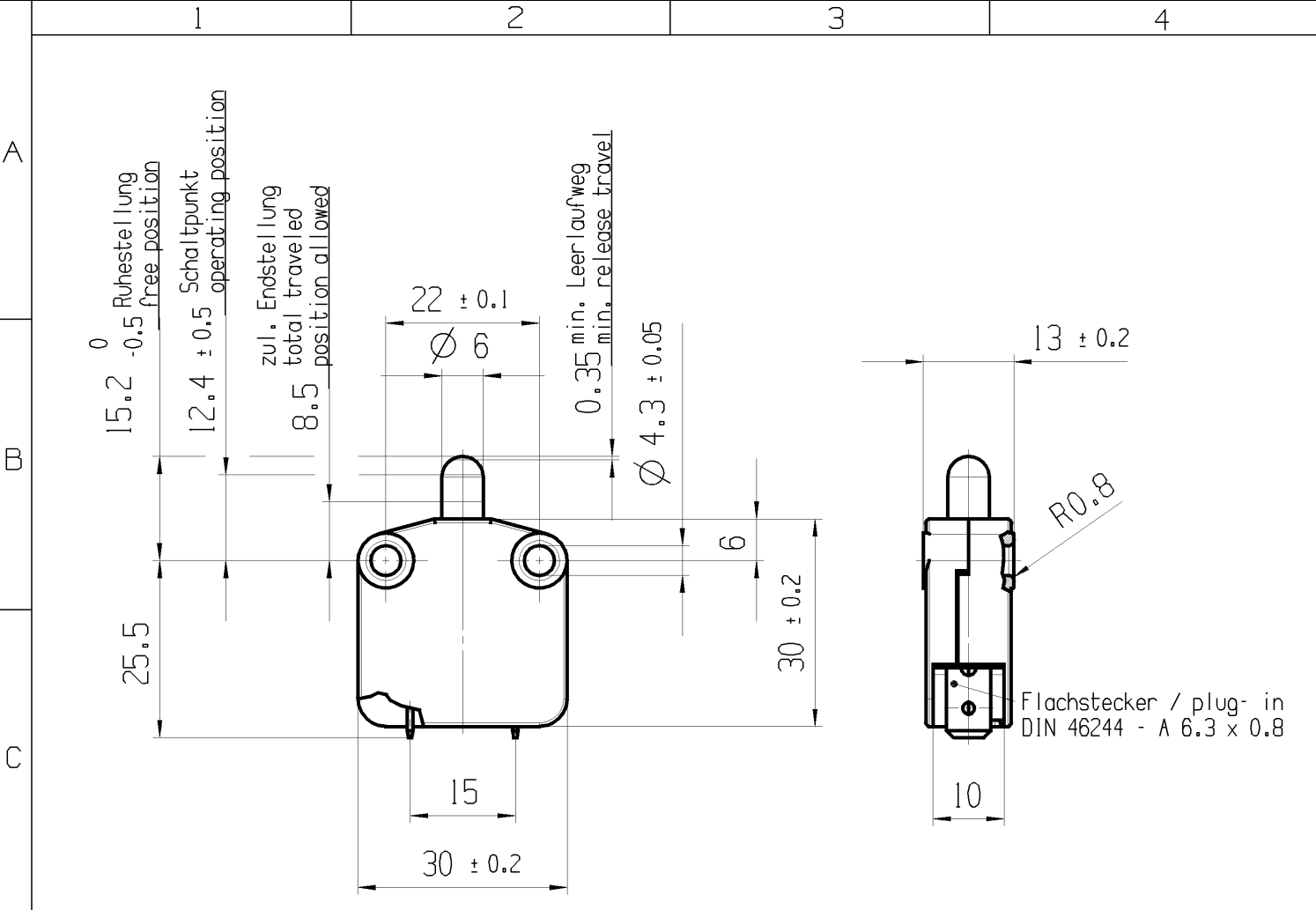
VERTRAULICH CONFIDENTIAL
 © THIS DRAWING IS THE EXCLUSIVE PROPERTY OF MARQUARDT GMBH. WITHOUT THEIR CONSENT IT MAY NOT BE REPRODUCED OR GIVEN TO THIRD PARTIES.
 © Alle Rechte bei Marquardt GmbH, auch fuer den Fall von Schutzrechtsmeldungen. Jede Veruegungsbefugnis, wie Kopier- und Weitergaberecht, bei uns.



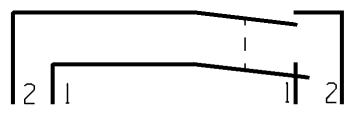

Aufschrift
 Marking
 MARQUARDT 
 1117.
 16(16)/400 ~ T85
 05
 12A 125 - 250 V AC
 1/6 HP 125 V AC
 1/2 HP 250 V AC
 R84 
 T.-Nr. 6577900

Oeffner 1-polig
 Schalt-Betaetigungskraft 3.5N ± 0.5N
 Differenzweg (Weg zwischen Schaltpunkt und Rueckschaltpunkt) max. 2.6
 SPNC
 actuating force 3.5N ± 0.5N
 movement differential (movement between operating position and release position) max. 2.6
 Rd ≤ 100 mΩ bei/at I > IA
 G-Konform nach IEC 60335-1:2001 Kap.30
 G-matching IEC 60335-1:2001 clause 30



Auf Verpackung / on box : T.-Nr.6577900
G

fuer Form und Lage FOR SHAPE AND LOC. fuer Winkel FOR ANGLE ± 2°	 =	Allgemeintoleranzen UNTOLERANCED DIMENSIONS				Pause COPY	Blatt SHEET 01	TYP K	Zeichn./DRAWING NO. 11170206	Index c
	PROJEKTION 	Abmasse und Nennmassbereiche Angaben in mm	Laenge LENGTH	Radien RADII	Original Masstab SCALE Din A4 1:1 30mm					

c	48695	10.08.06	HHE		
b	47541	30.05.06	BRC		
a	44287	04.08.05	BRC		
	42508	21.04.05	BRC		

CAD: NX V2.0
 gez./DRAWN BY 04.08.05 BRC
 gepr./CHECKED BY
 Ersatz fuer/REPLACEMENT OF
 Zg.gl.Nr.v.20.04.05

GERAETESCHALTER
 appliance switch

